

ANNUNCIATOR

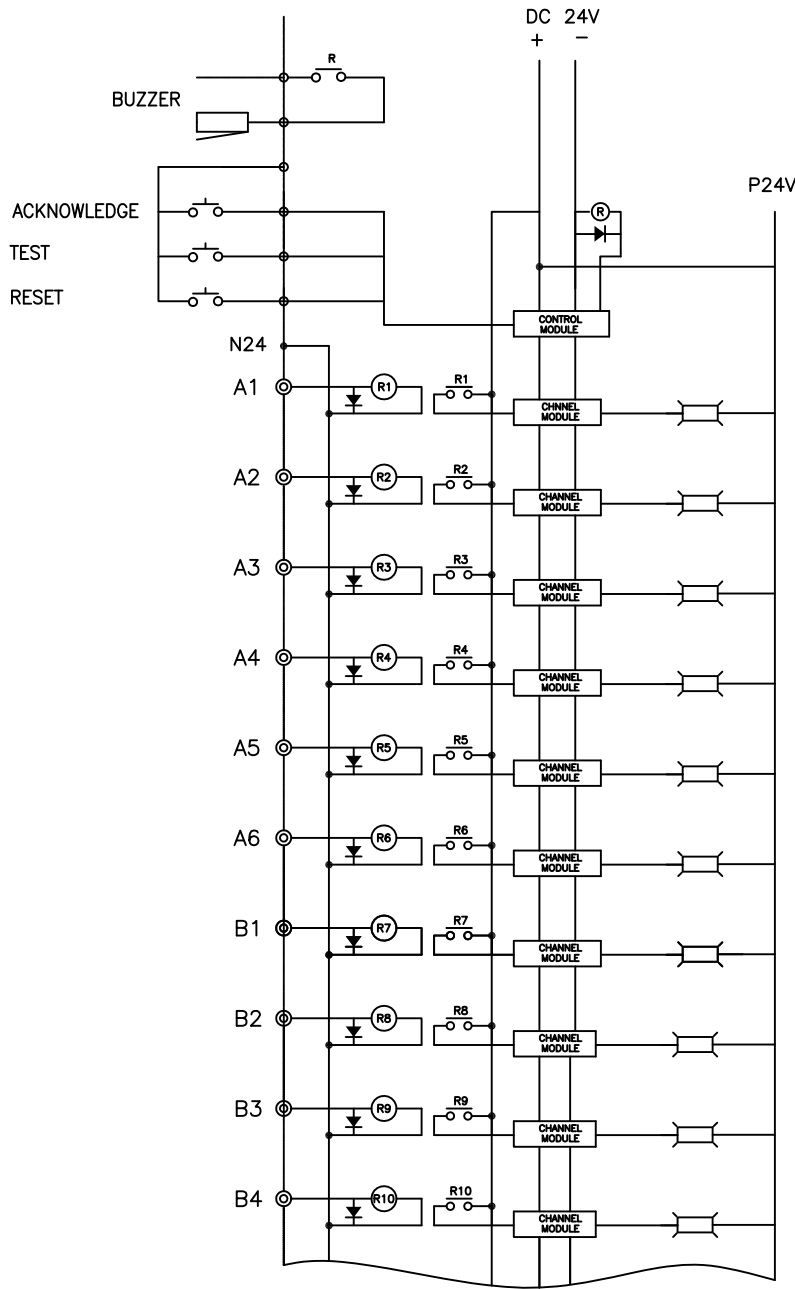

OPTION

1. COMMON TROUBLE ALARM

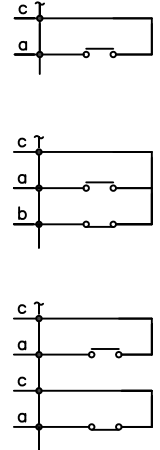

2. RELAY OUTPUT

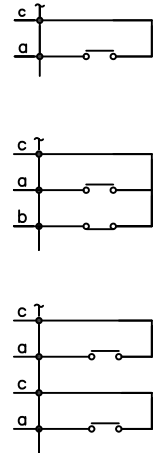

3. AUDIBLE

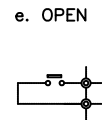
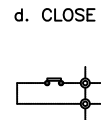
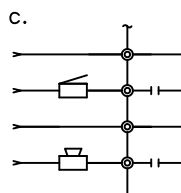
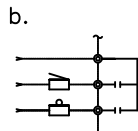
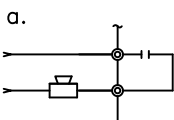

4. PUSH BUTTON SWITCH

